

結線図

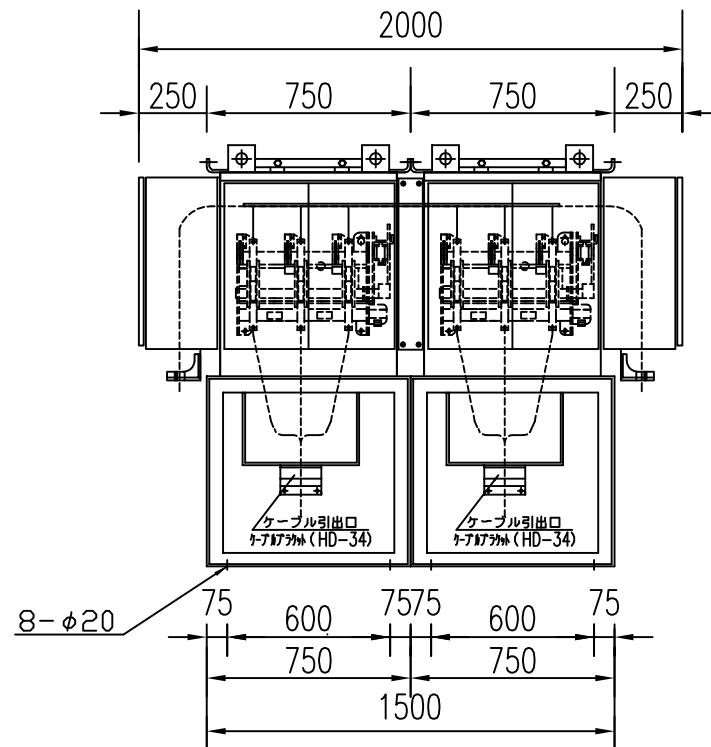
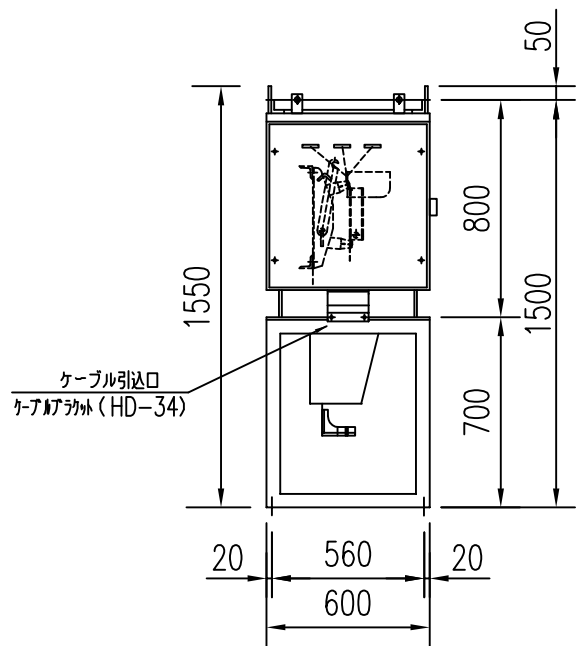
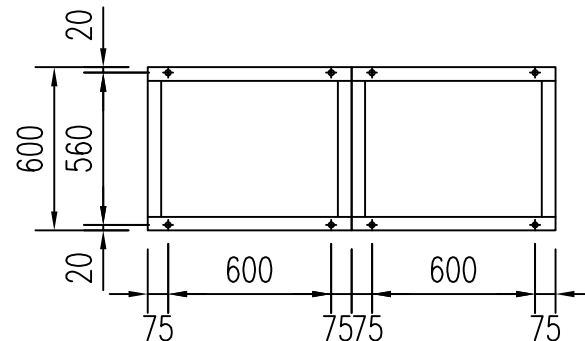
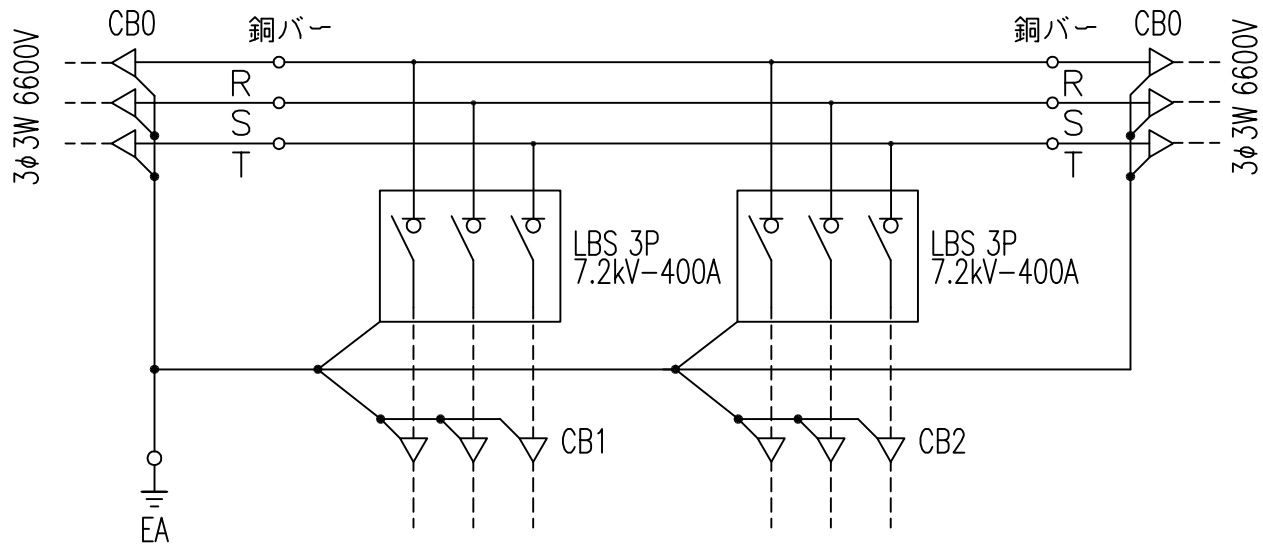

概算重量：340kg

株式会社 シンテクノ SHINTECHNO Corporation	名称： 高圧分岐盤	商品コード： YC6 10000 001
		図面No. B-2W